

水性环保 乳胶墨水印刷方案

Water Based Latex Ink Digital Printing Solution



免涂层
No Coating



免加热
No Heating



纯水性
100% Aqueous Ink



无气味
No UV/SOL

企业简介 COMPANY PROFILE

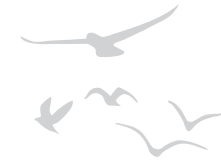

郑州鸿盛数码科技股份有限公司 成立于2001年，专注喷墨墨水研发生产22年，致力于喷墨墨水的研发、生产、销售；同时提供完善的数码印花及印刷解决方案，提供专业、高效的售前、售中、售后服务。

HONGSAM拥有独立知识产权和品牌，是行业领先的喷墨墨水生产商和综合应用解决方案提供商，为全球100多个国家和地区的客户提供优质产品与解决方案。

HONGSAM的核心价值观：科学、诚信、环保、超越，并坚持“鸿盛+”的经营理念，根植于产业，愿同更多的企业广泛联结，深度合作，共同为人类创造数字新生活！

Founded in 2001, Zhengzhou Hongsam Digital Science and Technology Co., Ltd. specialized in R&D, manufacturing, producing and sales of inkjet inks over 22 years. Hongsam has become a professional provider of complete digital printing solution with the professional and high efficient pre / after sale services.

HONGSAM rewarded with the independent intellectual property right for numerous patents, is famous as a leading manufacturer and comprehensive application solution provider for inkjet ink , serving more than 100 different countries' customers with high quality products and solutions.

HONGSAM always regards Science, Honesty, Environment-friendly and Transcendancy as its core value and guided by HONGSAM PLUS philosophy, willing to establish extensive connection and deep collaboration with other companies to create a new digital life for mankind.

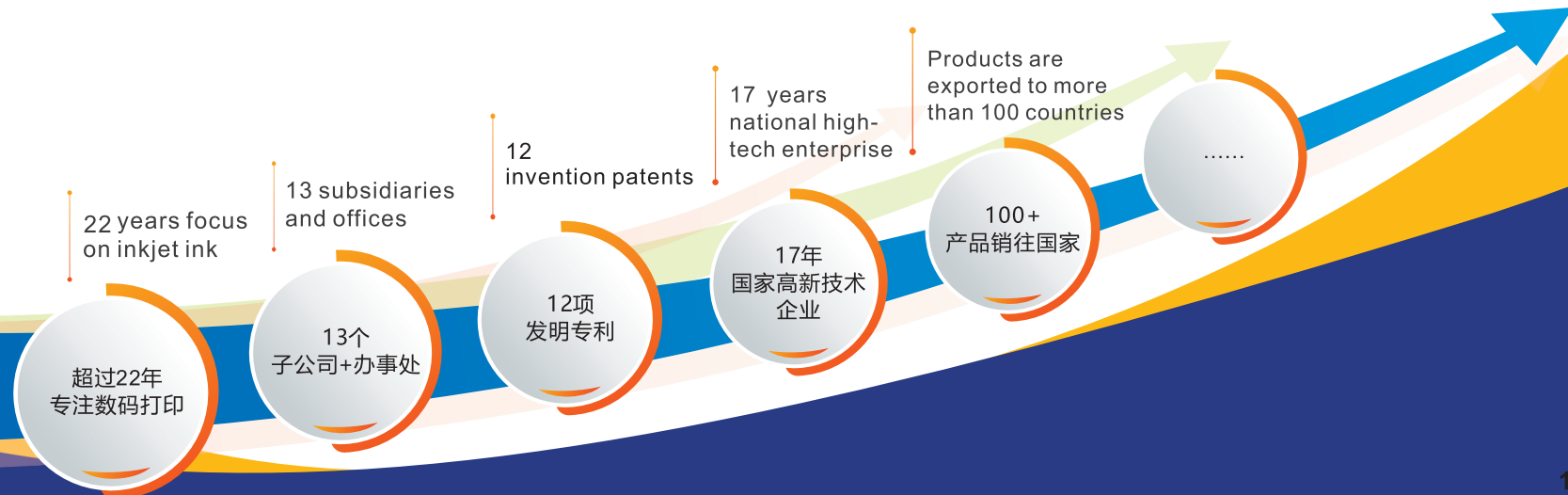

JETALL水性环保乳胶墨水, 真正的环保, NO UV, NO Solvent JETALL Water Based Eco-friendly Latex Ink , NO UV, NO Solvent

工艺特性

- 使用水性环保乳胶墨水, 墨水环保无气味、无腐蚀。
- 免涂层, 适应介质广泛。
- 色彩艳丽, 饱和度高, 色域宽广。
- 干湿摩擦、日晒色牢度高。
- 耐拉伸, 耐弯折, 耐高温, 耐冰冻, 耐酒精、丙酮、酸碱。

适应介质

- 深浅PU、PVC、PET、PP、杜邦纸、铜版纸、牛皮纸、无纺布等。

应用领域

- 皮革软装、箱包鞋材、室内装饰、广告标识、医疗卫生、包装印刷等。

Features

- No smelling, no corrosion.
- Coating free, suit for various types of media.
- Vivid color, high saturation, wide color gamut.
- High dry/wet rubbing fastness, high light fastness.
- High resistance to stretching, bending, high temperature, freezing , alcohol/acetone/acid.

Substrates

- Dark/light-color PU, PVC, PET, PP, Tyvek, Art paper, Kraft paper, Non-woven cloth, etc.

Applications

- Leather soft furnishings, suitcases, bags, shoes, interior decoration, advertising signs, medical health, packaging printing, etc.

材料免涂层/打印免加温

Media need no coating before printing & no heating during printing



- 独特OP墨水配方, 配合专用彩色、白色墨水, 适应更多材料, 可在无涂层介质上实现打印。



- 打印区域无需加热, 无需辐射烘干, 更好的保护材料安全和喷头安全。

- Unique OP(optimizer) ink is used in conjunction with professional color ink & white ink, suit for printing on various types of materials, including the uncoated media.
- Printing area does not need heating or radiation drying, more safe to the printhead and printing material.

JETALL水性环保乳胶墨水

JETALL Water Based Eco-friendly Latex Ink



- 全系列水性环保乳胶墨水配方, 符合国家VOC排放要求, 在满足多种材料打印的同时, 兼顾生产环境和产品应用环境安全。



- 墨水本身没有UV墨水刺鼻的气味, 没有弱溶剂墨水的腐蚀性, 打印的产品无气味、无腐蚀、无挥发, 满足环保需求。

- All latex ink can meet the national VOC emission requirement. Not only enables to print on different types of materials, but also it's safe to the manufacturing environment and final application.
- Latex ink has no pungent smell of uv ink, no corrosion of eco-solvent ink. The prints has no smell, no corrosion and no volatilizing, is environment friendly.

HONGJET MP-1802L 乳胶打印机 Latex printer

网带打印平台，拓宽客户业务范围
Mesh Belt Printing Platform, expanding user's business scopes

- 网带吸风打印平台，平台走料打印，采用工业级大功率风机，吸附力强，传动平稳。
 - 通过分区、可调的强力吸风功能，使材料输送平整，避免材料打印时出现变形、皱褶、粘附、刮蹭等情况。
 - 适应材料广，对于厚薄、软硬、强拉伸等各种特性材料，都能提供更环保、更高附加值的打印解决方案，拓宽客户业务范围。
 - 进口直线导轨；进口德国线材；进口大功率交流伺服电机；墨车防撞装置；全自动供墨、缺墨报警系统。
- Use mesh belt platform to feed the printing material, adopts industrial grade high-power fans to guarantee smooth transmission.
 - The partitioned and adjustable powerful air suction function, can feed the printing material smoothly and falt, totally avoiding the deformation, wrinkle, sticking, scratching during printing.
 - Suit for different kinds of media, especially the materials with specific thickness, hardness and stretchability, all can be printed with this printer. This high value-added printing solution is more Eco-friendly, can greatly expand user's business scope.
 - Imported linear guide rail; Germany imported wires; imported high-power AC servo motor; Carriage anti-collision device; Fully automatic ink supplying & alarming system.



产品参数 SPECIFICATIONS

打印参数 Printing Specifications			电脑配置 Computer Configuration	
喷头类型 Printhead	EPSON i3200-A1		电脑要求 Computer	CPU: i5 内存: 8GB以上 CPU : i5 internal storage>8GB
喷头数量 Printhead No.	3-4		电脑系统 System	Win7 \Win10
输出精度 Output Precision	360×1800dpi 720×1200dpi 720×1080dpi 720×2400dpi		打印接口 Interface	USB
打印速度* Speed*	OP+W+彩 OP+W+color	OP+W+彩+彩 OP+W+color+color	打印软件 Software	MainTop、PhotoPrint
经济模式 Economy mode	22m ² /h	34m ² /h	电源参数 Power Source	AC-220V,50Hz/60Hz
生产模式 Production mode	16m ² /h	25m ² /h	机器功率 Power	3KW
品质模式 Quality mode	13m ² /h	20m ² /h	机器包装参数 Packaging Specifications	
墨水配置 Ink configuration			机器尺寸 Machine Dimension	3760×1130×1600mm(L×W×H)
墨水类型 Ink type	水性环保乳胶墨水 Water-based Eco-friendly latex ink		机器净重 Net Weight	1000 kg
颜色配置 Color	KCMY (可选LC\LM\R\B\OR\FM\FY) +W+OP KCMY (LC\LM\R\B\OR\FM\FY for optional) +W+OP		包装尺寸 Package Dimension	3800×1180×1650mm(L×W×H)
供墨方式 Ink supplying	大容量供墨系统+缺墨报警+白墨循环 Big capacity ink supplying system+ink shortage alarm+white ink circulation		包装总重 Gross Weight	1100 kg

*注释项目会因配置不同略有偏差, 仅供参考; 产品规格配置以实物为准, 如有修改恕不另行通知。

*Printing speed varies with actual materials and machine configuration, above data for reference only.

HONGJET MP-3208L 乳胶打印机 Latex printer

超宽幅打印，更适合整体家装行业
Extra large format printing, more suitable for family decoration

- 水性乳胶墨水打印，成品无任何有害物质挥发，绿色环保，满足儿童房等高要求应用环境。
- 适用多种材料，无纺布、宣绒布、纸质、PVC、皮革、墙布材料均可打印。
- 干湿摩擦牢度好、日常打理好维护，不沾色、不掉色。不褪色。
- 3.3米经典幅宽，满足无缝壁画、工装、大幅面装饰画市场需求。
- Printed with water-based latex ink, the finished product does not have any VOC, is green and environmentally friendly, and meets high-demand application environments such as children's rooms.
- Suitable for a variety of materials, non-woven fabrics, velvet, paper, PVC, leather, wall covering materials can be printed.
- Good dry and wet rubbing fastness, good daily care and maintenance, no staining or fading and fade.
- The print width of 3.3 meters meets the market demand for seamless murals, tooling, and large-format decorative paintings.

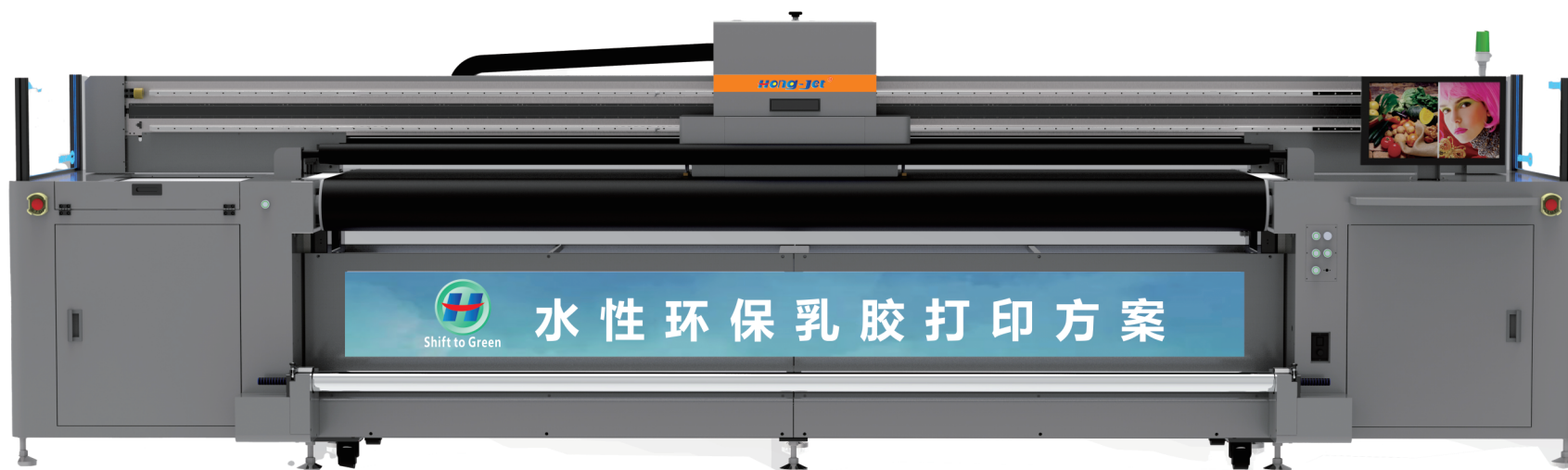

产品参数 SPECIFICATIONS

打印参数 Printing Specifications			电脑配置 Computer Configuration	
喷头类型 Printhead	EPSON i3200-A1		电脑要求 Computer	CPU: i5 内存: 8GB以上 CPU : i5 internal storage>8GB
喷头数量 Printhead No.	8		电脑系统 System	Win7 \Win10
输出精度 Output Precision	720×1200dpi 720×1800dpi		打印接口 Interface	USB
打印速度* Speed*	PASS	生产产能** Production capacity**	打印软件 Software	MainTop、PhotoPrint
720×1200dpi	2	77m ² /h	电源参数 Power Source	AC-220V,50Hz/60Hz
720×1800dpi	4	38m ² /h	机器功率 Power	6KW
720×1800dpi	6	25m ² /h	机器包装参数 Packaging Specifications	
墨水配置 Ink configuration			机器尺寸 Machine Dimension	5530 x 1600 x 1580 mm (L x W x H)
墨水类型 Ink type	水性环保乳胶墨水 Water-based Eco-friendly latex ink		机器净重 Net Weight	2000 kg
颜色配置 Color	KCMY (可选LC\LM\R\B\OR\FM\FY) +W+OP KCMY (LC\LM\R\B\OR\FM\FY for optional) +W+OP		包装尺寸 Package Dimension	5650 x 1650 x 1610 mm (L x W x H)
供墨方式 Ink supplying	大容量供墨系统+缺墨报警+白墨循环 Big capacity ink supplying system+ink shortage alarm+white ink circulation		包装总重 Gross Weight	2200 kg

*注释项目会因配置不同略有偏差, 仅供参考; 产品规格配置以实物为准, 如有修改恕不另行通知。

*Printing speed varies with actual materials and machine configuration, above data for reference only.

**生产产能: 本数据采用2OP+2W+4color色彩配置, 打印幅宽3200mm测得, 会因配置不同略有偏差, 仅供参考

**Production capacity: This data adopts 2OP+2W+4color configuration, and the print width is 3200mm.

There will be slight deviation due to different configuration, for reference only. .

HONGJET HJ-1600 乳胶写真机 Latex printer

适应各类卷材，表面无涂层介质
Applicable for various uncoated substrates of roll material

- 爱普生I3200喷头、静音导轨、防撞防刮蹭系统，确保高精度稳定输出；
- 配置8色水性乳胶墨水输出，绚丽色彩与水性环保缺一不可；
- 配套乳胶墨水专用烘干加热系统，低功耗、高效能，确保打印输出质量稳定；
- 常规材料、特殊材料都可实现完美打印，涉及多个应用行业领域，为客户创造更多高附加值应用。
- Epson I3200 print heads, THK silent guide rail, anti-collision and anti-scratch system ensure high-precision and stable output;
- Equipped with 8-color water-based latex ink output, gorgeous colors and water-based environmental protection;
- Equipped with special drying and heating system for latex ink, low power consumption and high efficiency, ensuring stable print output quality;
- Both conventional materials and special materials can be printed perfectly, involving multiple application industries, creating more high value-added applications for customers.



产品参数 SPECIFICATIONS

打印参数 Printing Specifications			打印介质 Computer Configuration		
喷头类型 Printhead	EPSON i3200-A1		有效幅宽 Effective width	1600mm	
喷头数量 Printhead No.	3-4	喷车高度 Printhead Height	2mm-8mm	介质类型 Medium type	相纸/背胶/油画布/PET/墙布/铜版纸/杜邦纸等 PhotoPaper/PP/PET/Art Paper/CoatedPaper/Tyvek
输出精度 Output Precision	720×1200dpi 720×1800dpi 720×2400dpi		收纸装置 Paper Dirve	标配，卷材最大外径250mm Standard，Maximum Outer Diameter 250mm	
打印速度* Speed*	OP+W+彩 OP+W+color	OP+W+彩+彩 OP+W+color+color	打印软件 Software	MainTop、RIIN	
经济模式 Economy mode	20m ² /h	35m ² /h	电源参数 Power Source	AC-220V,50Hz/60Hz	
生产模式 Production mode	14m ² /h	25m ² /h	整机功率 Power	最大功率：8KW，工作功率：3.2KW maximum power：8KW,working power：3.2KW	
品质模式 Quality mode	10m ² /h	18m ² /h	机器包装参数 Packaging Specifications		
墨水配置 Ink configuration			机器尺寸 Machine Dimension	2860 x 1335 x 1460mm (L x W x H)	
墨水类型 Ink type	水性环保乳胶墨水 Water-based Eco-friendly latex ink		机器净重 Net Weight	360 kg	
颜色配置 Color	KCMY (可选LC\LM\LK\LLK) +W+OP KCMY (LC\LM\LK\LLK for optional) +W+OP		包装尺寸 Package Dimension	2960 x 1500 x 1770 mm (L x W x H)	
供墨方式 Ink supplying	大容量供墨系统+缺墨报警+白墨循环 Big capacity ink supplying system+ink shortage alarm+white ink circulation		包装总重 Gross Weight	410 kg	

*注释项目会因配置不同略有偏差，仅供参考；产品规格配置以实物为准，如有修改恕不另行通知。

*Printing speed varies with actual materials and machine configuration, above data for reference only.

HONGJET HJ系列高效节能烘干机 High-efficiency Dryer

产品特性 Product Features

- 专利技术，行业首创，专业涂料转移烫画方案、水性环保乳胶方案定制产品。
 - 智能温控热风循环，低噪音、低功耗、烘干效率高、环保节能又省电。
 - 精准温控，分区控制，适应不同速度打印模式。
 - 操控方便，无材料损耗，为客户节约、降低打印成本。
 - 免维护、无易损件、无耗材，超长使用寿命。
- Pioneered technology with invention patent. Customized for Powderless DTF & Latex solutions.
 - Intelligent control hot air circulation, low noise, low consumption, high efficiency, Eco-friendly and power saving.
 - Precise temperature control on different areas separately, adapting to various printing modes.
 - Easier to operate, reduce printing consumables and cost.
 - Maintenance-free, less wearing parts, longer service life.



HJ-H60



HJ-H1901



HJ-H1902

应用图示 Application Graphic

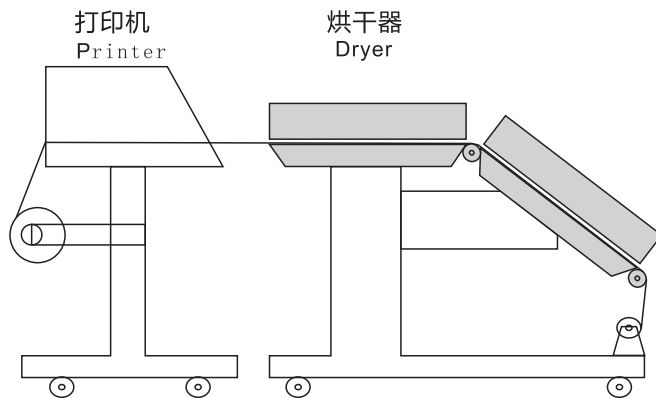

HJ-H60烘干机左视图
HJ-H60 Dryer's Left View

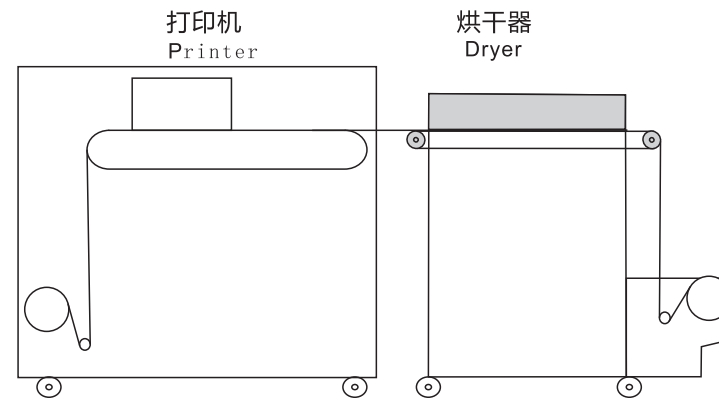

HJ-H1901/1902 烘干机左视图
HJ-H1901/1902 Dryer's Left View

产品参数 Specifications

产品型号 Product Model	最大幅宽 Maximum Width	额定功率 Rated Power	工作能耗* Work Energy*	电源 Power	外形尺寸 Product Dimension	重量 Net Weight	包装尺寸 Package Size	总重量 Gross Weight
H-H60	700mm	5.8KW	2.3KW/h	单相 Single-phase AC 220V 50/60Hz	1580×1100×1150mm	180kg	2360×1160×1360mm	240kg
HJ-H1901	1800mm	8.5KW	3.3KW/h		1730×2530×1130mm	800kg	1790×2590×1290mm	900kg
HJ-H1902	1800mm	16KW	6.5KW/h		3300×2480×1130mm	1500kg	3360×2540×1290mm	1600kg

*工作能耗：设定温度120°C，加热风速60%，实际运行一小时测得，仅供参考。

*Energy consumption is measured under condition: Set temp 120°C, Heating fan speed 60%, For reference only.

灵活的深色、浅色材料自适应打印模式 Flexible dark-color & light-color material self-adaption printing mode

- 对于深色材料，使用白墨打底，解决材料本色对图案色彩的影响，使您得到更加绚丽的真彩颜色表现。
- 对于浅色材料，仅需OP墨水配合彩色墨水打印输出，图案牢度和色彩表现优异。
- For the dark-color medium, using white color to create underbase, avoiding influence from the natural color of the material. OP + color ink brings more gorgeous turecolor performance.
- For the light-color medium, white is not necessary, just OP + color inks can generate excellent fastness and colors.

打印浅色材料 Light-color medium printing

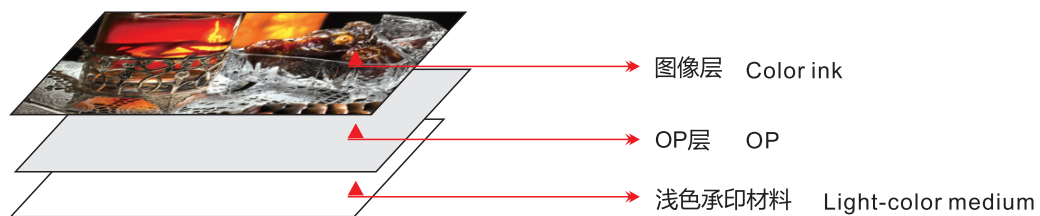

打印深色材料 Dark-color medium printing

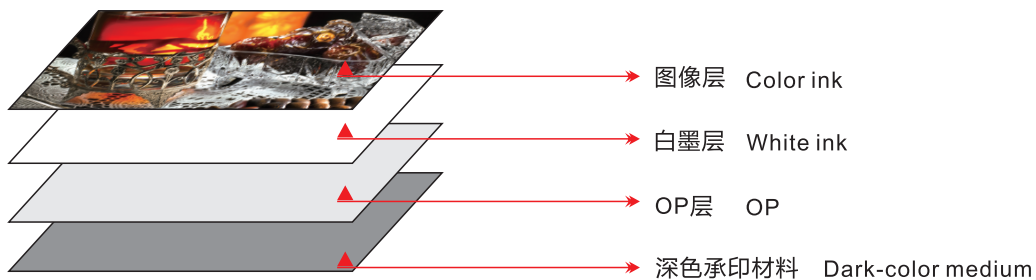



中国认可
国际互认
检测
TESTING
CNAS L0604



检测报告 Test Report SL22102292623601TX 日期 Date:2021年08月12日 页码 Page 1 of 8 检测报告 Test Report SL22102292623601TX 日期 Date:2021年08月12日 页码 Page 4 of 8

下列样品由客户提供及确认为:

The following sample(s) was/were submitted and identified on behalf of the client as:

委托单位 Consignor	郑州鸿盛数码科技股份有限公司 ZHENGZHOU HONGSAM DIGITAL SCIENCE& TECHNOLOGY CO.,LTD
委托单位地址 Consignor address	郑州市高新区玉兰西街10号鸿盛数码科技园 NO.10,YULAN WESTERN STREET, HIGH TECHNOLOGY INDUSTRIAL ZONE, ZHENGZHOU, HENAN, CHINA
样品描述 Sample Descriptions	(A)JETALL 水性乳胶墨水数字印刷杜邦纸
颜色/色号 Color	(A)MULTI (A)彩色
纤维成分/材质 Fiber Content/Material	(A)polyethylene (A)聚乙烯
最终用途 End Use	(A)Clothing and decoration (A)服饰、装饰
样品数 No of Sample	(A)8
安全类别 Safety Category	C类 Category C
产品等级 Product Grade	一等品 First Grade
检测类别 Test Type	委托送样检验 Submitted (sample sent by client)

样品送达日期 Sample Receiving Date	2021-08-09
检测周期 Testing Period	2021-08-09 - 2021-08-12

检测依据 Document Accordance	详见检测结果页 Details please see test result page
判定依据 Judgement Accordance	GB 18401-2010 国家纺织产品基本安全技术规范 - C类 GB 18401-2010 National general safety technical code for textile products - Category C 测试项目 Test items
检测结论 Test Conclusion	本报告仅提供实测数据和单项判定, 详见检测结果/汇总页, 检测结果仅适用于收到的样品 The report only give the test result and Individual Judgment, detail please see follow page, the results only apply to the sample(s) as received.

检测结果及评判
Test Results and Judgment

GB 18401-2010 国家纺织产品基本安全技术规范 - C类 / GB 18401-2010 National general safety technical code for textile products - Category C

检测项目及测试方法 TestItem & Test method	判定 Judgment	样品 Sample	单位 Unit	技术要求 Requirement	测试结果 Test Result	
耐干摩擦色牢度 Colour Fastness To Dry Rubbing GB/T 3920-2008	符合 PASS	A	级 Grade	≥3	干摩擦沾色 Dry Staining	4
耐水色牢度 Colour Fastness To Water GB/T 5713-2013	符合 PASS	A	级 Grade	≥3	变色 Colour Change	4-5
			-	-	沾色 Staining	
			级 Grade	≥3	聚酯纤维 Polyester	4-5
耐汗渍色牢度 Colour Fastness To Perspiration GB/T 3922-2013	符合 PASS	A	级 Grade	≥3	酸性 Acid	4-5
			-	-	变色 Colour Change	
			级 Grade	≥3	酸性 Acid	4-5
			级 Grade	≥3	沾色 Staining	
			级 Grade	≥3	酸性 Acid	4-5
			级 Grade	≥3	羊毛 Wool	4-5
			级 Grade	≥3	碱性 Alkaline	4-5
			-	-	变色 Colour Change	
			级 Grade	≥3	碱性 Alkaline	4-5
			级 Grade	≥3	沾色 Staining	
			级 Grade	≥3	碱性 Alkaline	4-5
			级 Grade	≥3	聚酯纤维 Polyester	4-5



除非另有书面协议, 本报告由本公司依据《服务通用条款》出具。
《服务通用条款》印刷在正本报告纸背面, 或通过 <http://www.sgs.com/en/Terms-and-Conditions.aspx> 查询, 电子格式文件可通过 <http://www.sgs.com/en/Terms-and-Conditions/Terms-e-Document.aspx> 获取。请特别关注其中涉及责任限定, 赔偿以及司法管辖的相关条款。任何报告的持有方需知悉, 此报告内容仅反映SGS受限于客户指示下, 且在当时所得结论。SGS仅对其客户负责, 并且此报告不能免除交易各方根据交易文件所享有的权利和应履行的义务。未获得本公司书面批准, 本文件不得进行复制, 全文除外。任何未经授权对报告内容及形式进行的修改、伪造或扭曲都是违法行为, 违法者将会被追究法律责任。
注意: 检测/检验报告或证书的真实性, 请通过电话 (86-755) 83071443 或邮箱 CN.Doccheck@sgs.com 查询。
中国·山东·青岛市崂山区株洲路143号通标中心 邮编: 266101 1 (86-532) 68998888 www.sgsagroup.com.cn sgs.china@sgs.com

应用市场介绍
Applications Introduction



箱包/鞋材/皮革
Suitcase & Bag /
Shoes / Leather



家装软包/墙布
Home Decoration Soft
Furnishings /Packaging

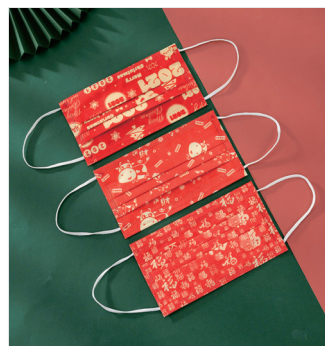

无纺布/口罩/手提袋
Non-woven cloth/
Mask/Hand Bag



广告/车贴/软膜
Advertisements/
Car Sticker/Soft Film



交通指示/反光贴
Traffic Signs /
Light Reflection Sticker



纸箱/瓦楞纸/铜版纸
Carton / Corrugated
Paper / Art Paper



室内软垫/汽车脚垫
Indoor Soft Pad /
Car Foot Pad



建材/装饰画
Construction Material/
Decoration Photo



标签/PET膜
Labels/PET Film



杜邦纸/包装袋
Tyvek/Packaging Bag

ABOUT US
关于我们 >>>

Hong-Jet®



科学

SCIENCE



诚信

HONESTY

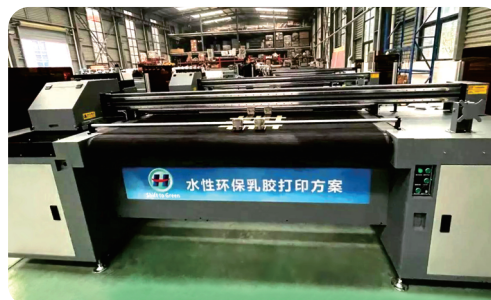

环保

ENVIRONMENT-FRIENDLY



超越

TRANSCENDENCY





环保 是“我”的底线!

Eco-friendly is our bottom line

多介质 打印是“我”的追求!

Multi-media printing is our pursuit

诚招行业、区域代理

Agents
Recruitment



李工: 15303720105
王工: 13937131790